

Data Sheet

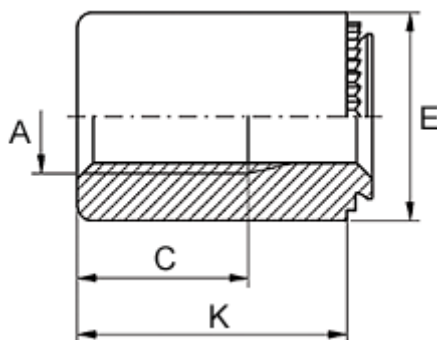

Article number: 12517800230500
Description: KLEE-coil 517 800 230.500
M3 Stainless 1.4305

Measures



Female thread A	= M3
Height K	= 17
Min distance to edge	= 4.0
Outer diameter E	= 7
Plate thickness	= 1.5 to 2.3
Recommended bore diameter +0.05	= 5.00
Thread length	= 8.0